

ダイヤカット折り紙円筒のFEMモデル化におけるソルバー依存性

9012139 仲山 史晃

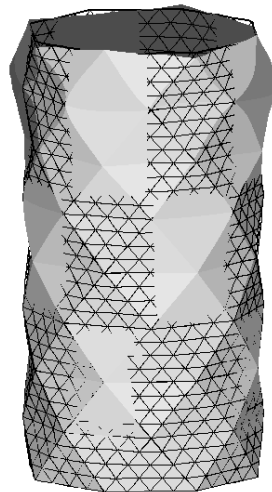

Calculix



異なるモード

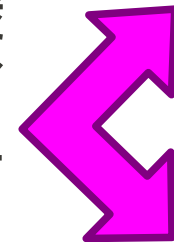

Marc

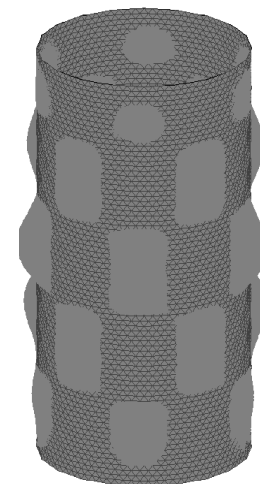
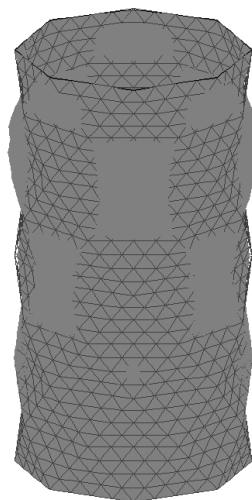

FEMでモデル化

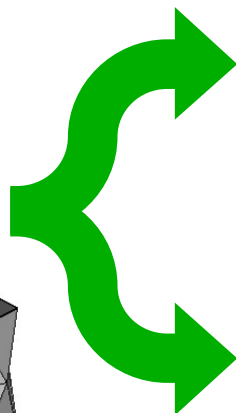
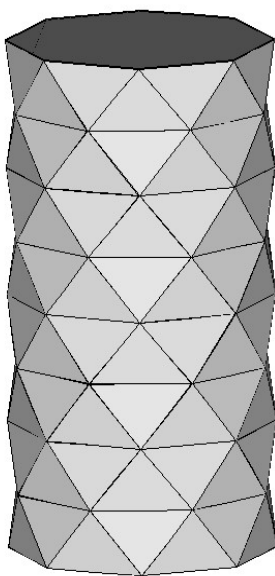

解析モデル（角柱）

ヤング率 69GPa

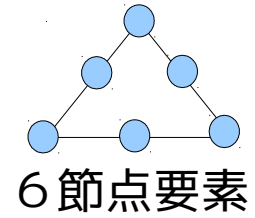

・ 周分割

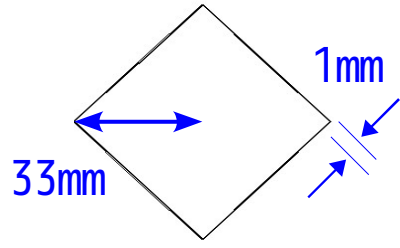

4角

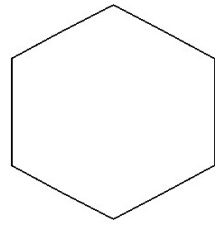

6角

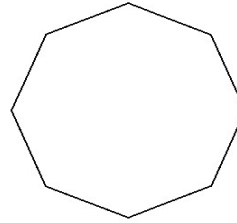

8角

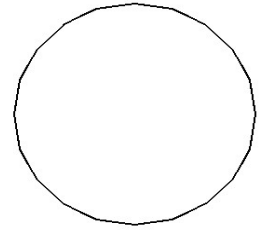

20角

・ 高さ分割

例) 四角柱の場合

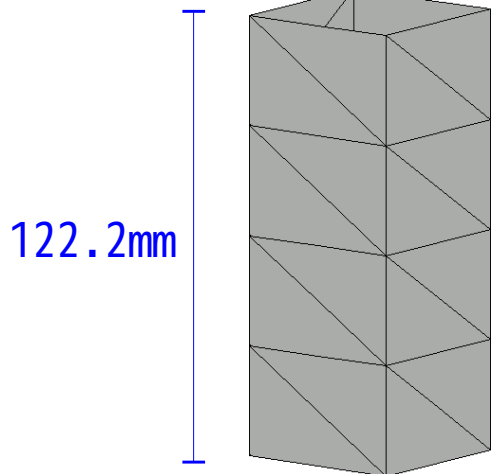

4段

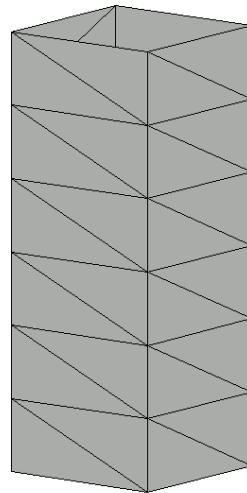

6段

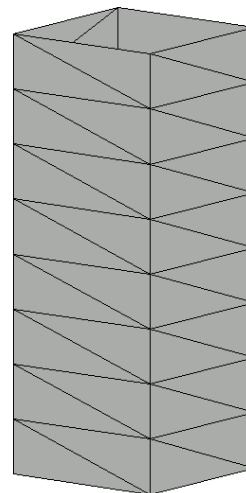

8段

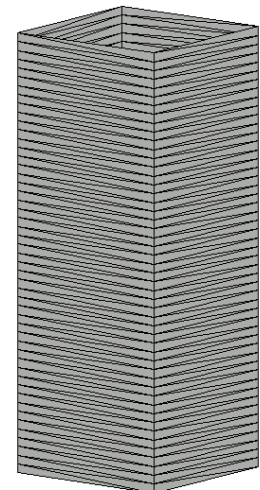

300段

載荷方法

上端の節点(周分割数)に均等に
載荷する

荷重 1KN

水平方向変位
を拘束

全節点固定

122.2mm

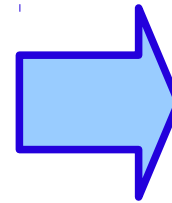
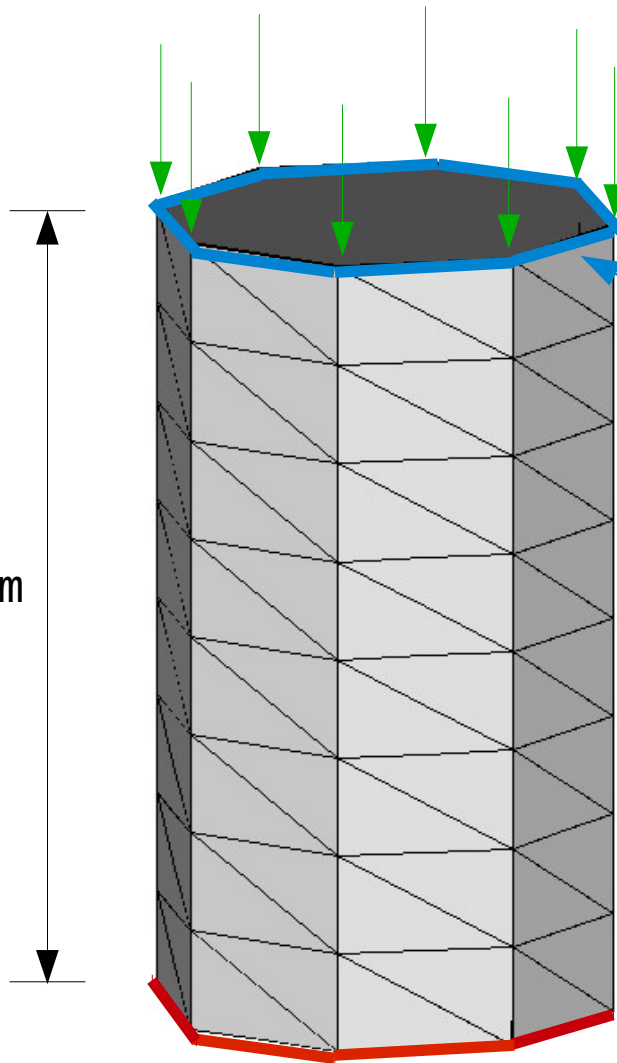

- ・ バネ定数
- ・ 座屈モード

をみていく。

角柱のバネ定数比較

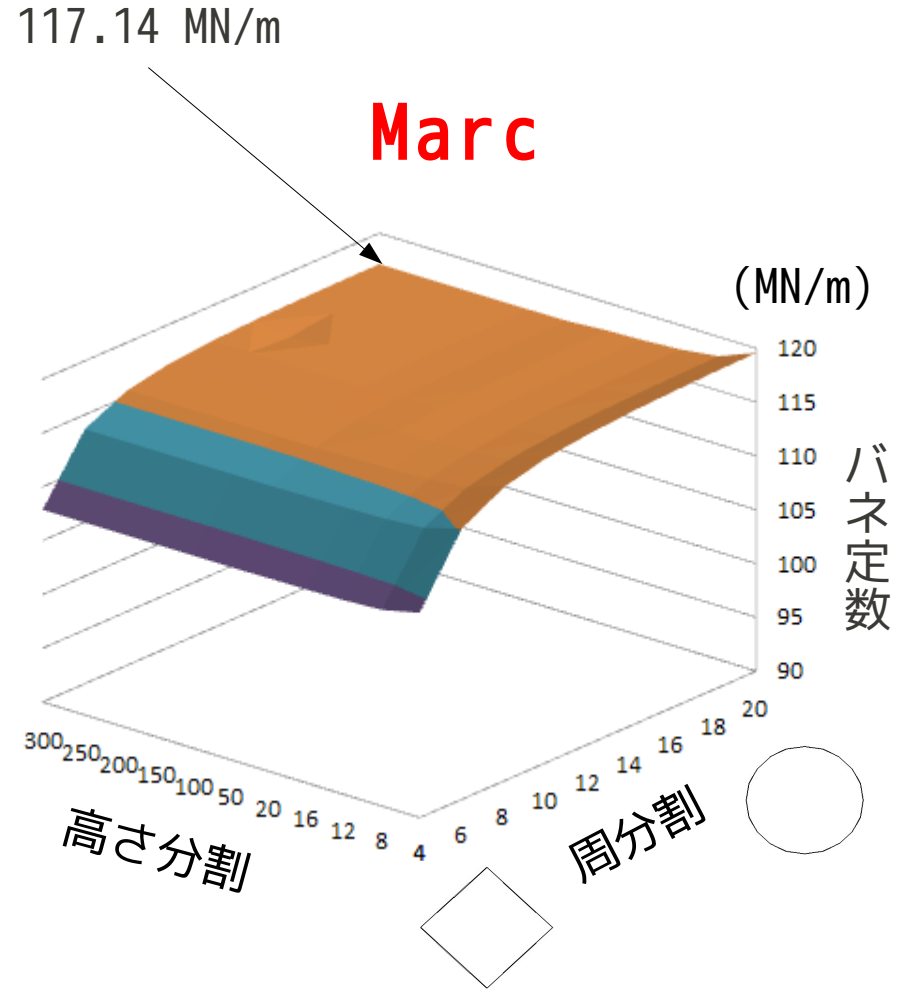
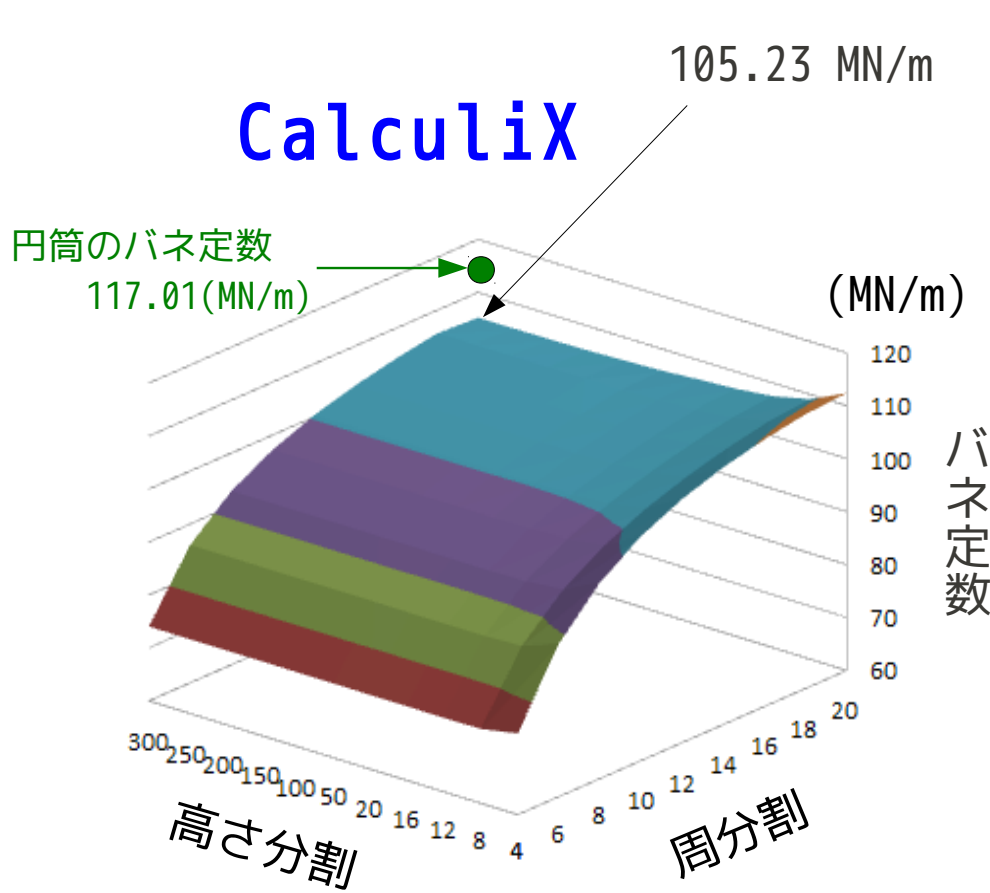

高さ方向分割50から収束した値となった

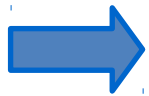

周方向分割を増やすことで収束はあるのか？
CalculiXとMarcを比較した際の誤差はどうか？

高さ分割50と固定

周分割を多くし、断面を真円に近づける

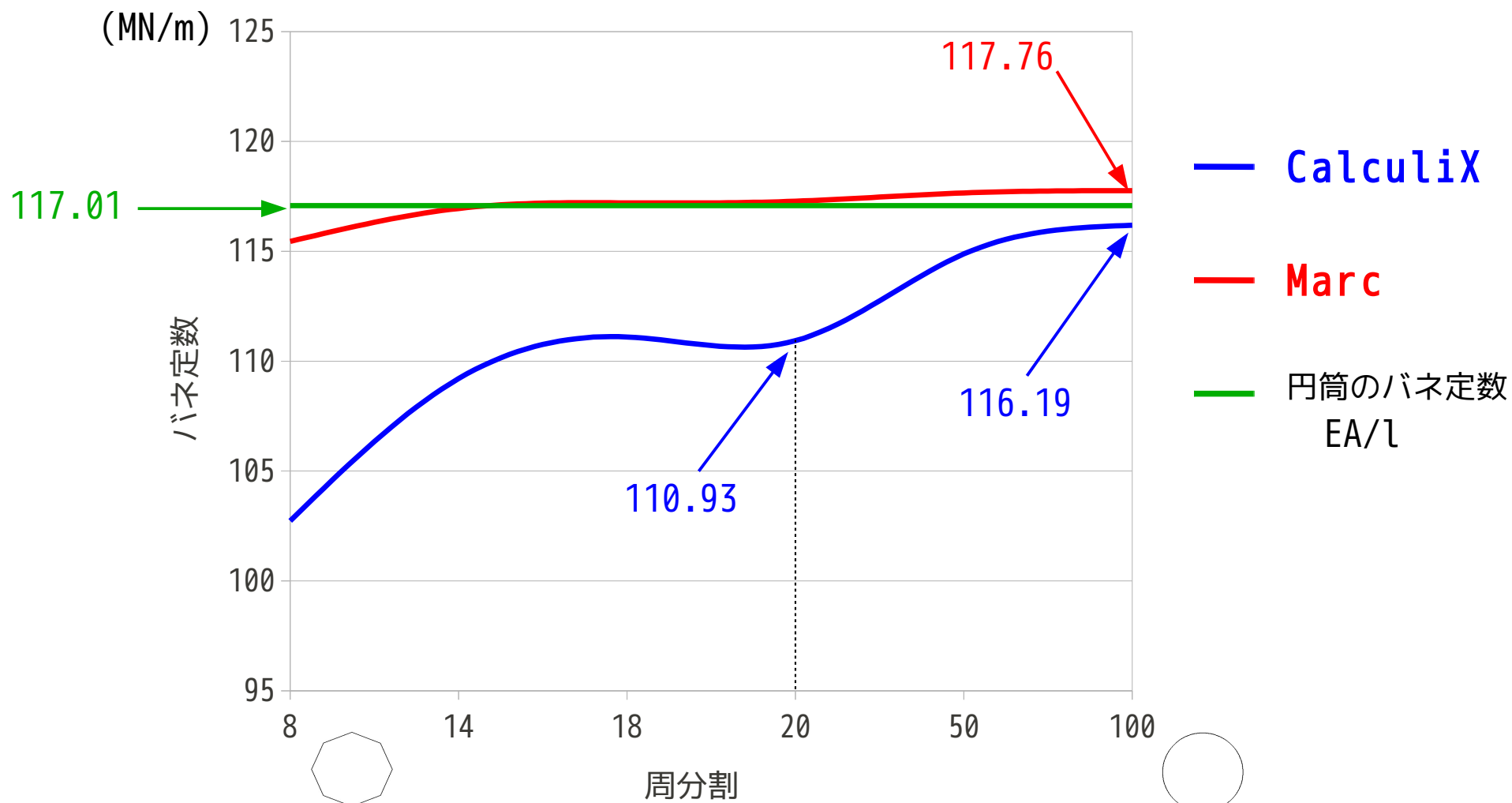

座屈モードの比較 (その1)

CalculiX

Marc

1次

周8

周18

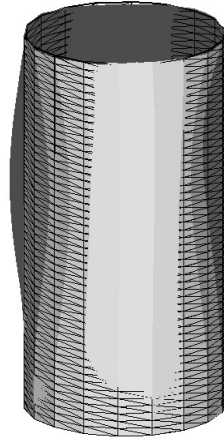
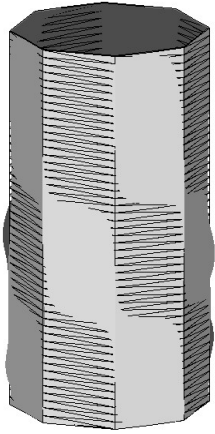

0.201 MN

0.281 MN

2次

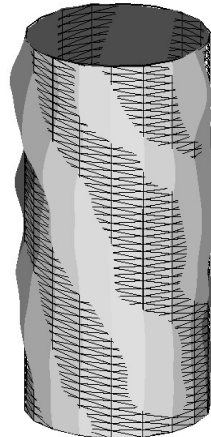
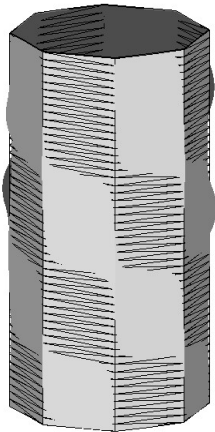

0.208 MN

0.306 MN

周8

周18

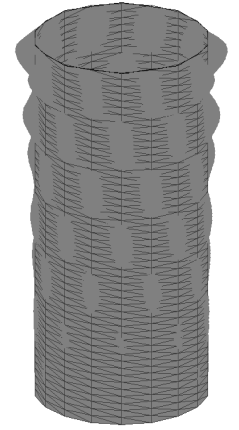
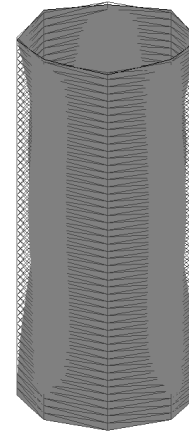

0.342 MN

0.209 MN

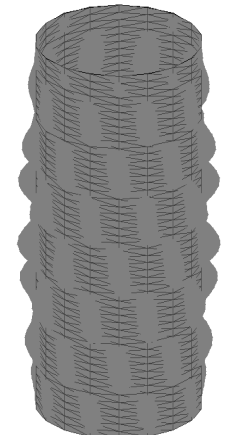
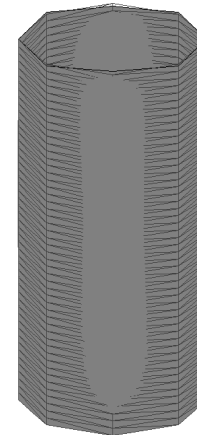

0.395 MN

0.210 MN

座屈モードの比較 (その2)

CalculiX

Marc

1次

周54

周100

周54

周100

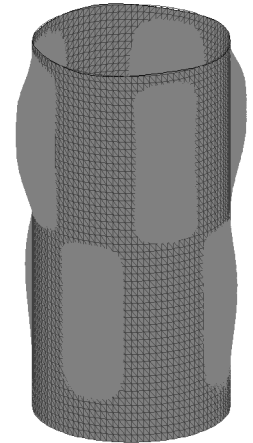
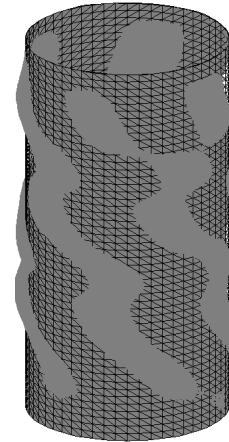
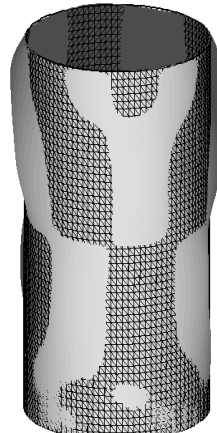
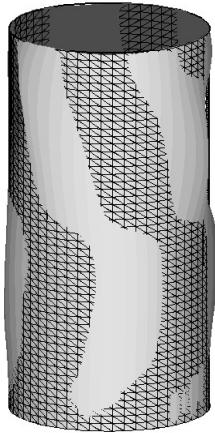

0.244 MN

0.243 MN

0.239 MN

0.244 MN

2次

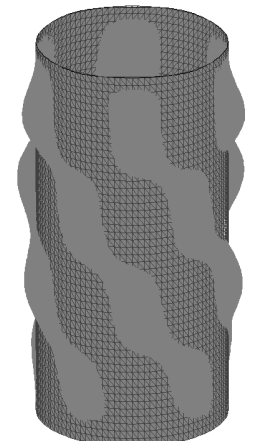
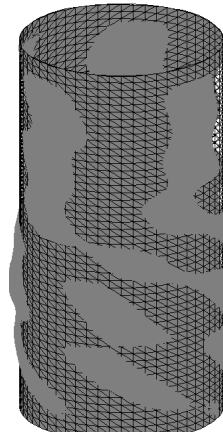
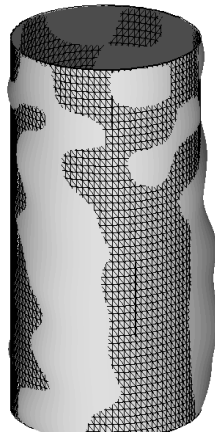
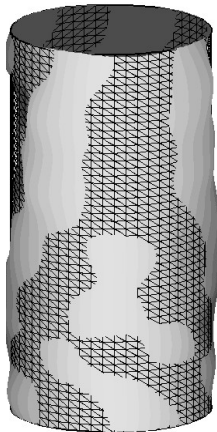

0.256 MN

0.255 MN

0.239 MN

0.244 MN

解析モデル (ダイヤカット)

ヤング率 69GPa

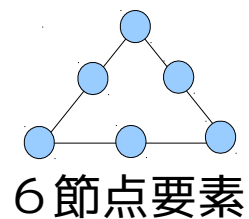

・ 周分割

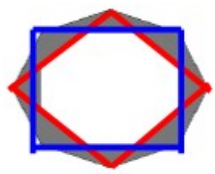

4角

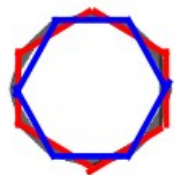

6角



8角



10角

.....

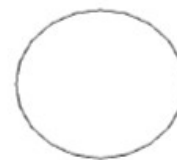

20角

1mm

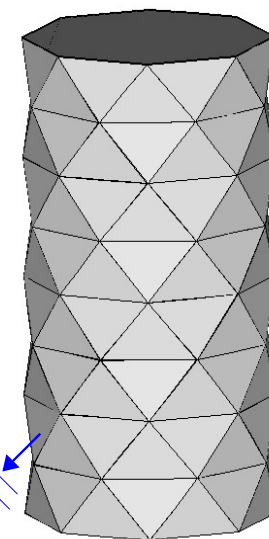

・ 高さ分割

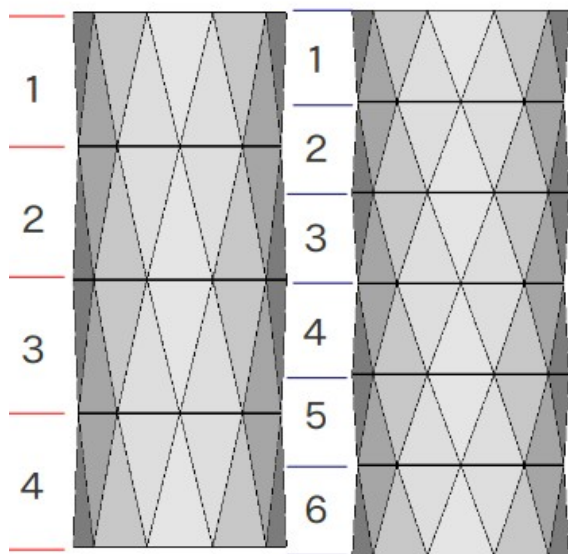

4段

6段

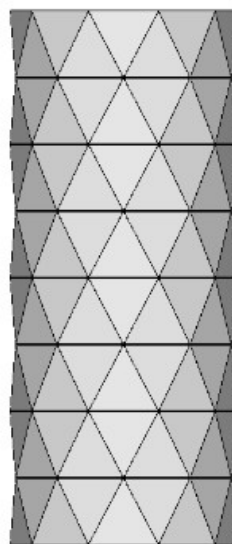

8段

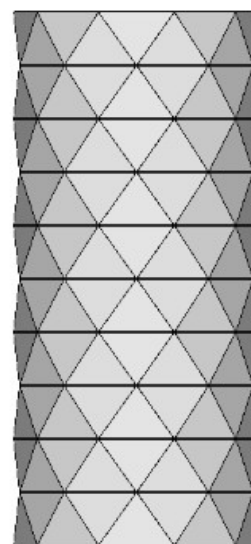

10段

.....

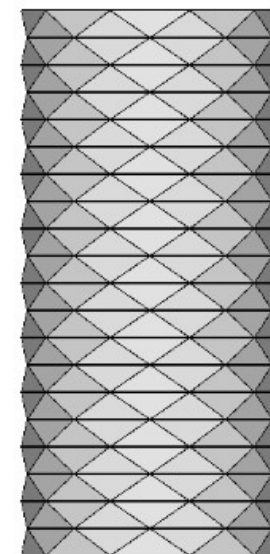

20段

33mm

122.2mm

・ 三角形 1 要素分割

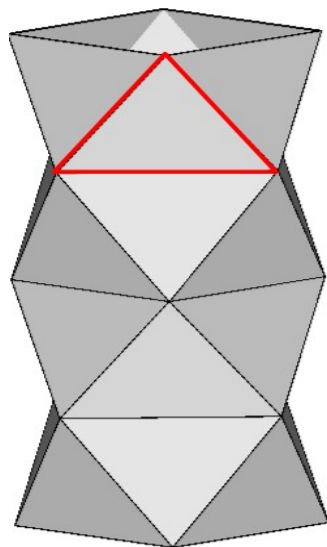

1分割数

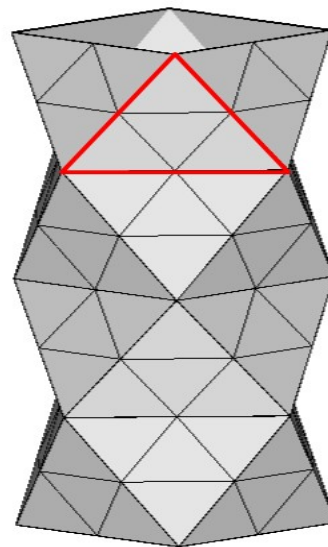

4分割数

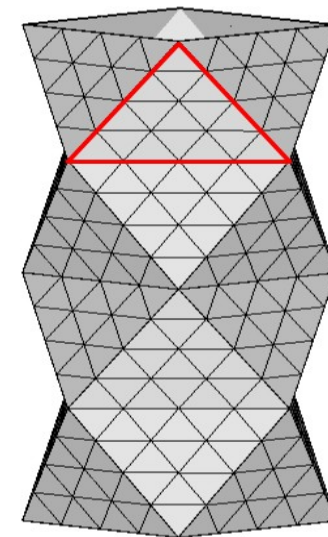

16分割数

載荷方法

(角柱と同様)

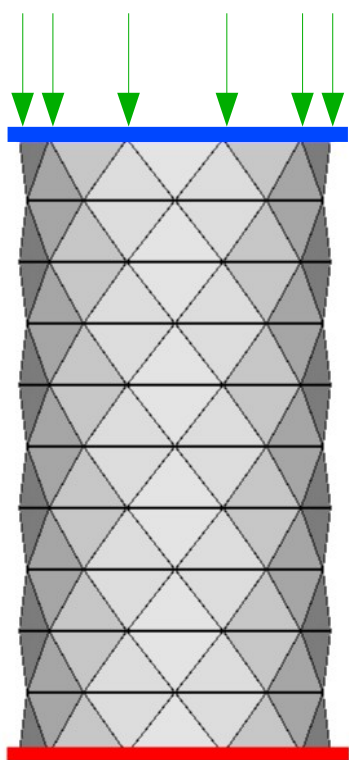

荷重 1KN



- ・ バネ定数
- ・ 座屈荷重
- ・ 座屈モード

をみていく。

バネ定数

三角分割 1

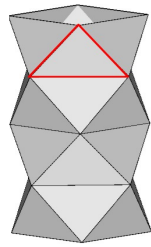

三角分割 4

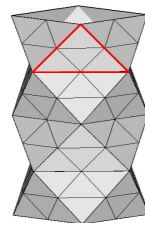

三角分割 16

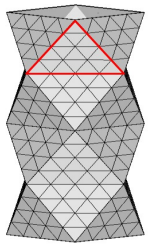

CalculiX

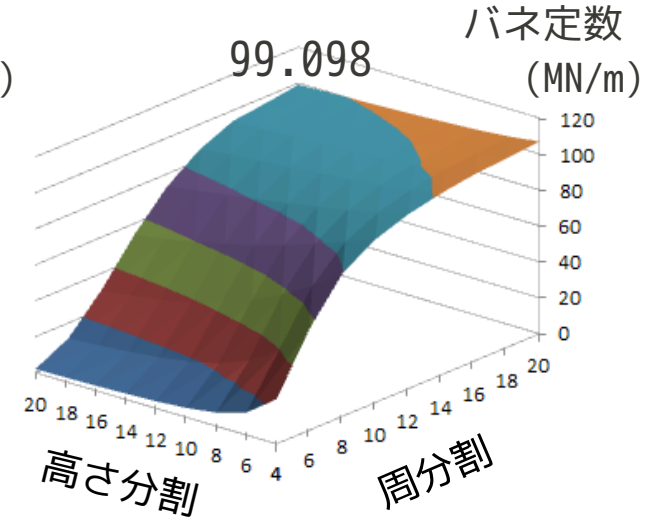
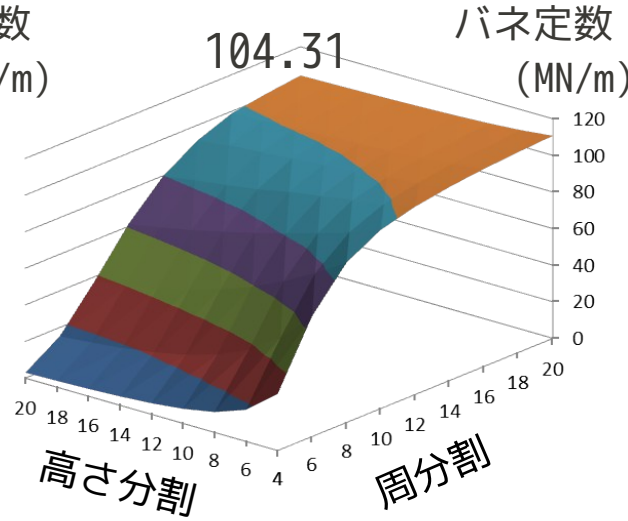
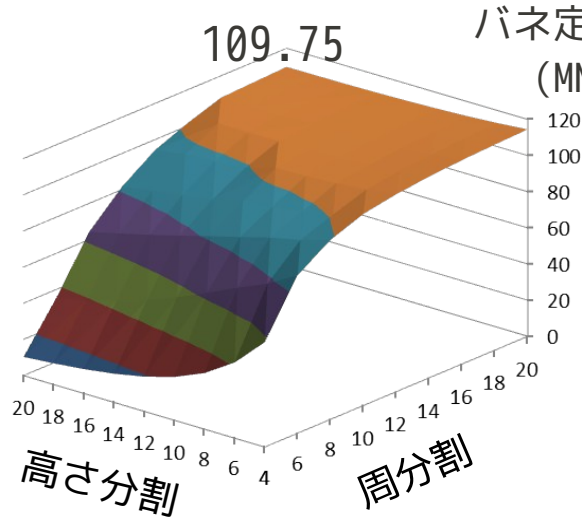

Marc

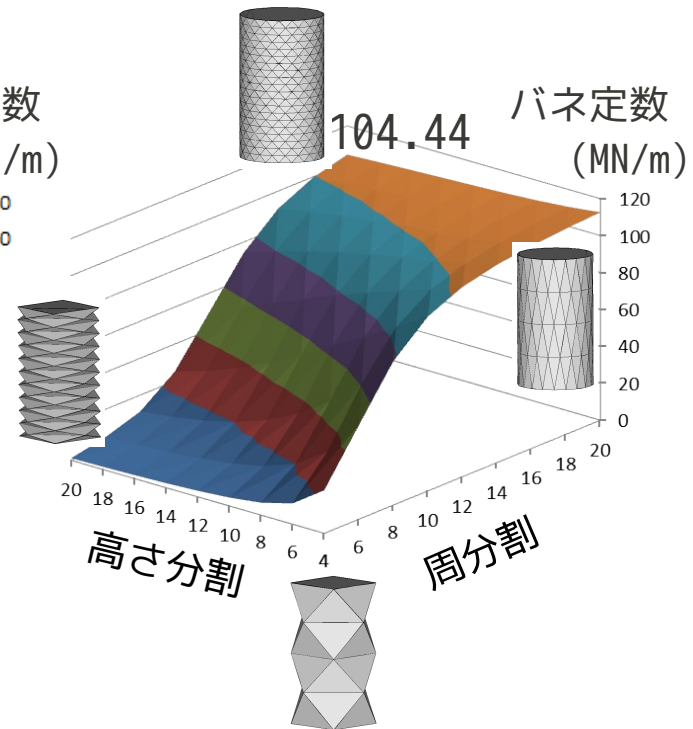
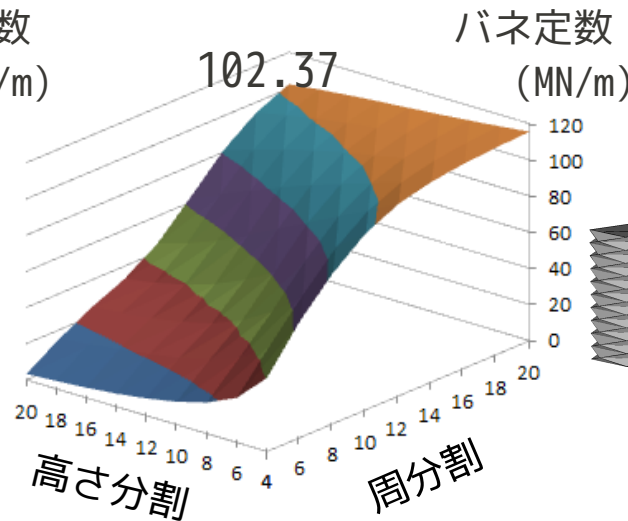
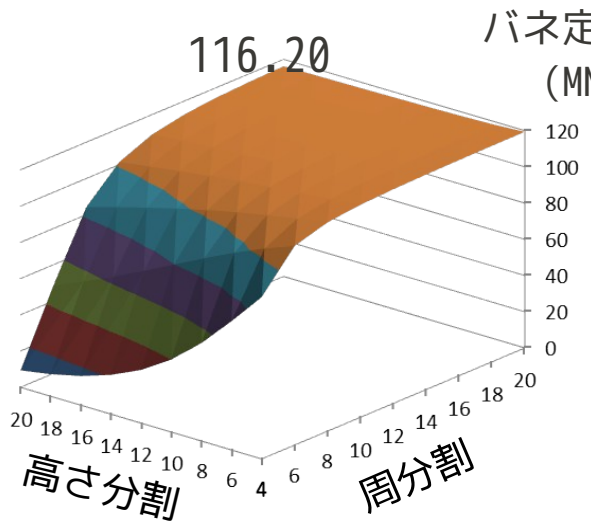

座屈荷重

三角分割 1

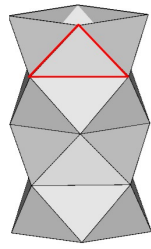

三角分割 4

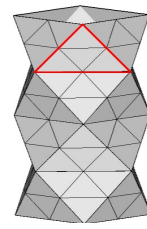

三角分割 16

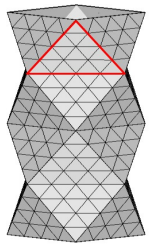

座屈荷重
 $\times 10^{-1}(\text{MN})$

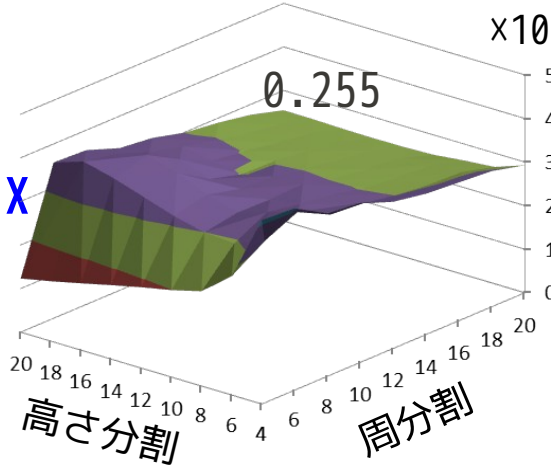

座屈荷重
 $\times 10^{-1}(\text{MN})$

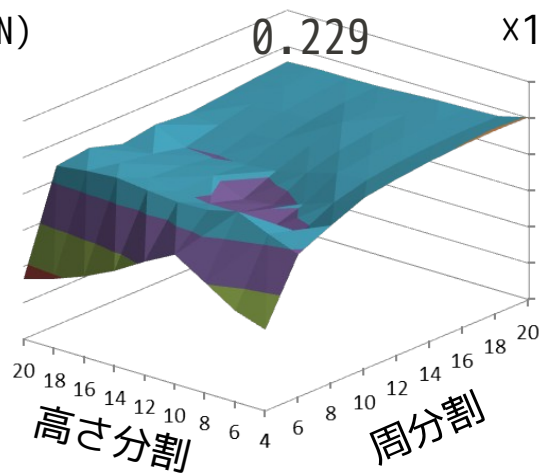

0.227

座屈荷重
 $\times 10^{-1}(\text{MN})$

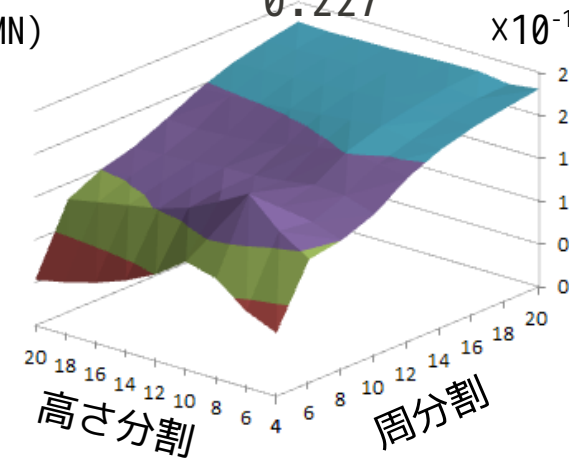

座屈荷重
 $\times 10^{-1}(\text{MN})$

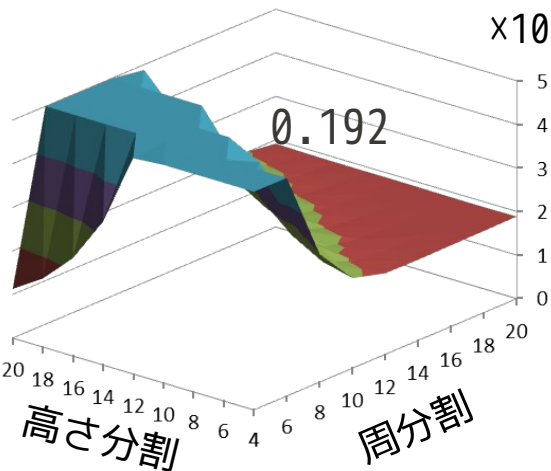

座屈荷重
 $\times 10^{-1}(\text{MN})$

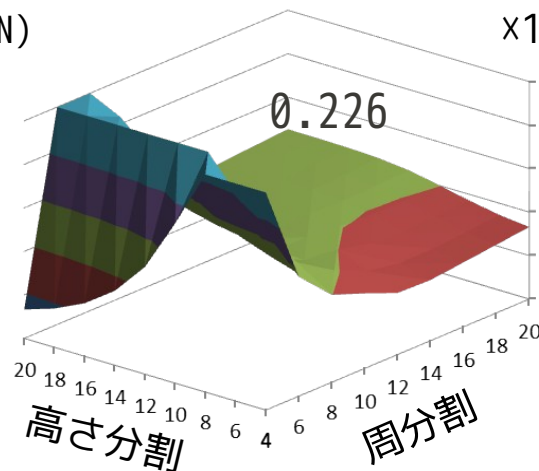

座屈荷重
 $\times 10^{-1}(\text{MN})$

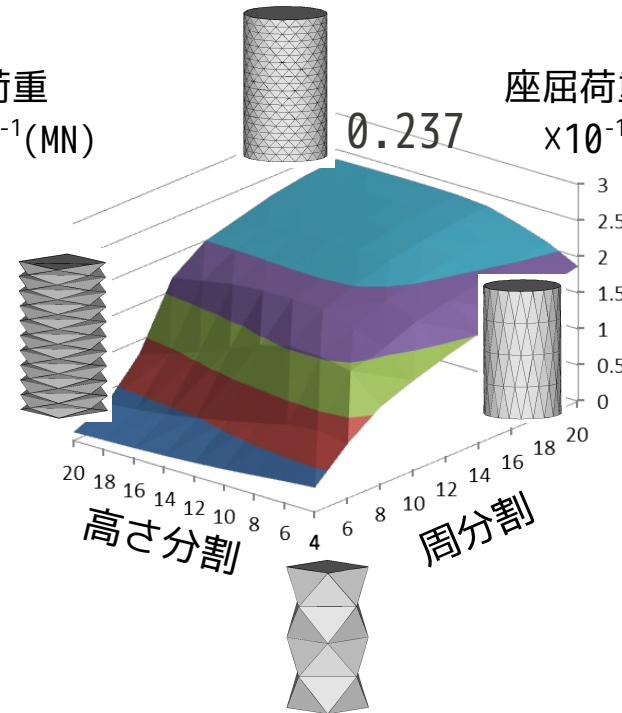

CalculiX

Marc

座屈モード

1次

2次

3次

周分割 8
高さ分割 8
三角分割 16

Calculix

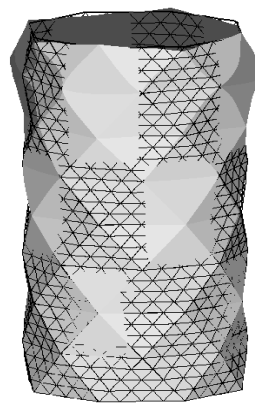

0.169
MN

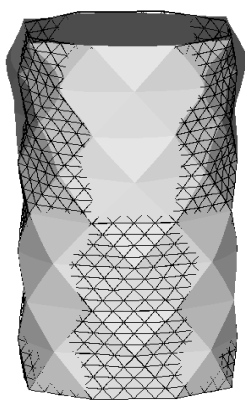

0.182
MN



0.203
MN

Lanczos

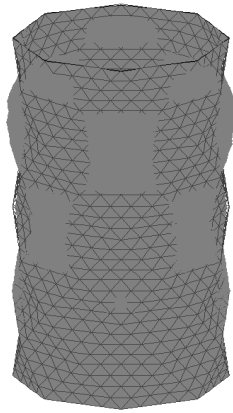

0.153
MN

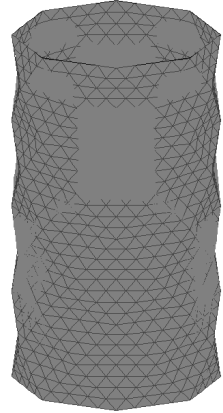

0.153
MN

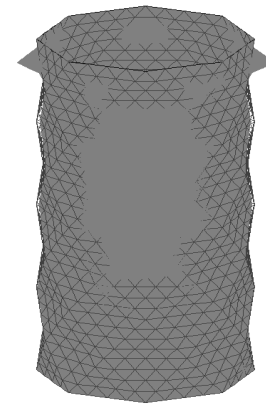

0.155
MN

Marc

Inverse Power

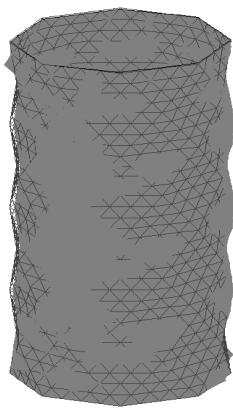

0.197
MN

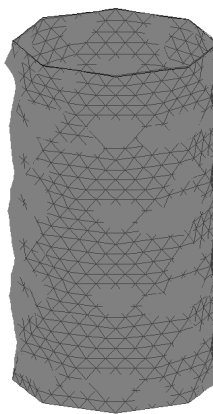

0.189
MN

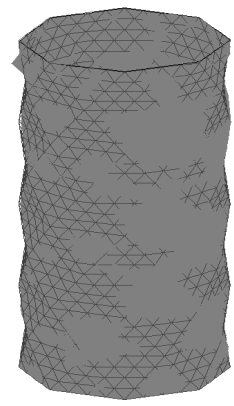

0.198
MN

座屈モード

1次

2次

3次

周分割 20
高さ分割 20
三角分割 16

Calculix

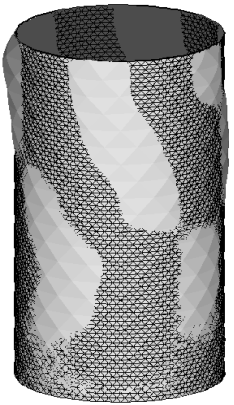

0.227
MN



0.235
MN

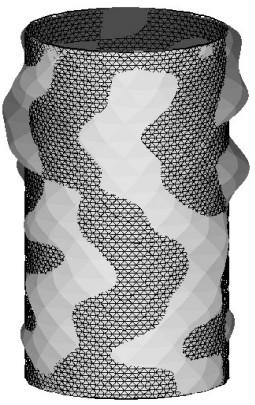

0.256
MN

Lanczos

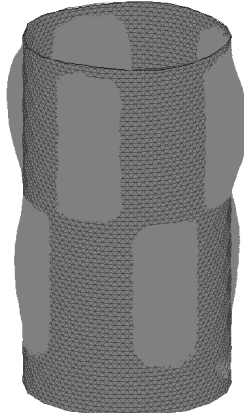

0.237
MN

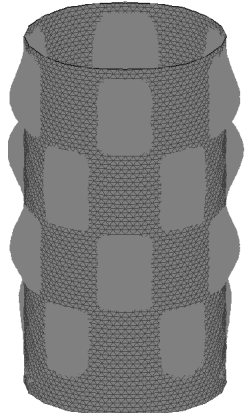

0.241
MN

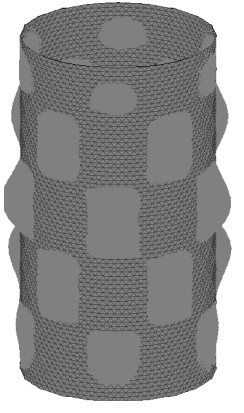

0.242
MN

Marc

Inverse
Power

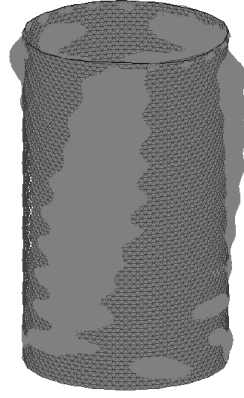

0.322
MN

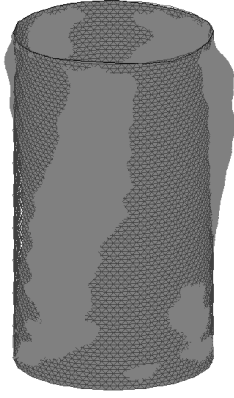

0.302
MN

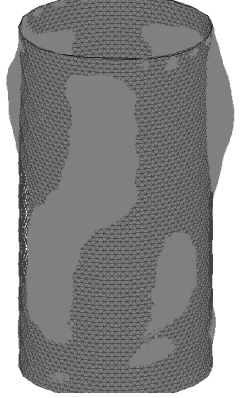

0.282
MN

まとめ

CalculiX

Marc

1分割

16分割

1分割

16分割

バネ定数

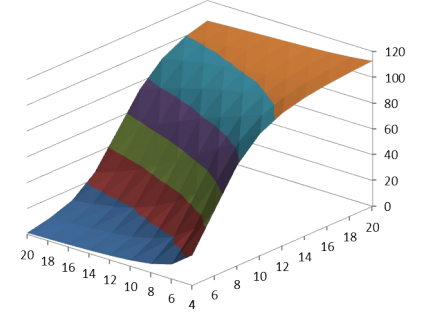
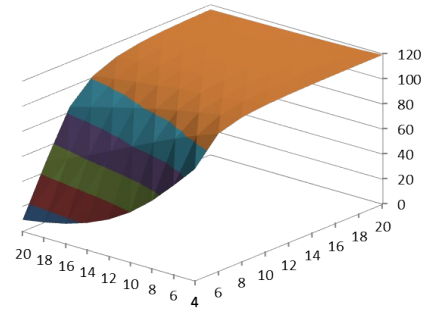
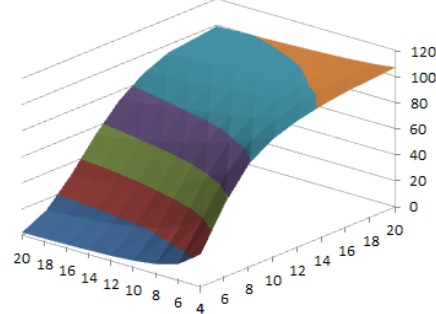
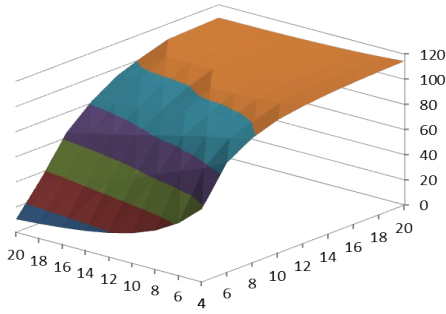

座屈荷重

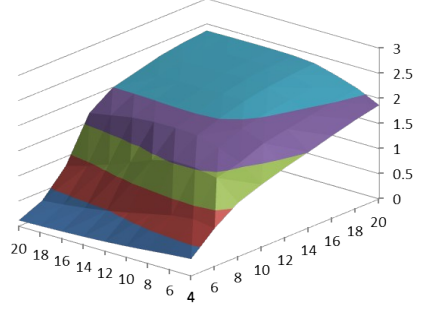
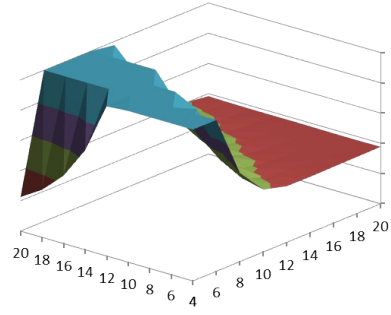
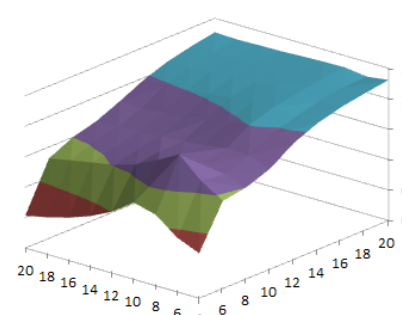
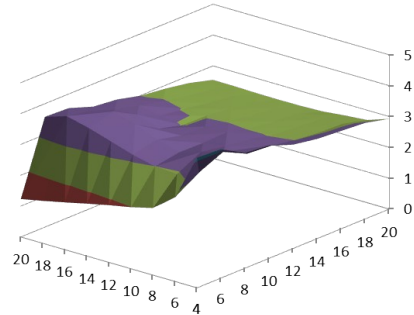

座屈モード

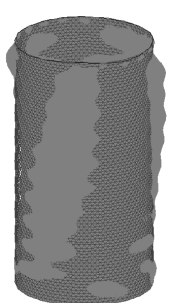
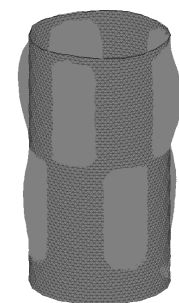
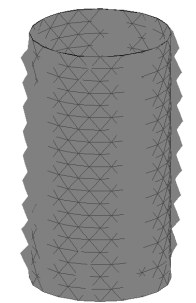
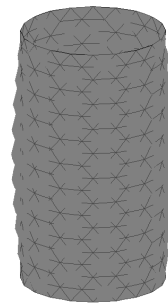
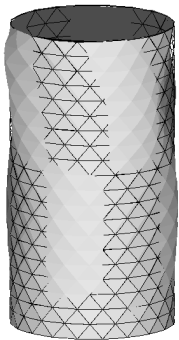

Lanczos

Inverse Power

Lanczos

Inverse Power

CalculiX、Marc双方においてメッシュ依存性はみられる

解析ツール及び手法により偏りがある